

NVR301-S2 Series



Key Features

- Support Ultra 265/H.265/H.264 video formats
- 4/8-channel input
- Third-party IP cameras supported with ONVIF conformance: Profile S, Profile G, Profile T
- Support 1-ch HDMI, 1-ch VGA
- HDMI and VGA simultaneous output
- Up to 6MP resolution recording
- 1 SATA HDD up to 6 TB
- Support cloud upgrade

Specifications

Model	NVR301-04S2	NVR301-08S2
Video/Audio Input		
IP Video Input	4-ch	8-ch
Network		
Incoming Bandwidth	40Mbps	50Mbps
Outgoing Bandwidth	40Mbps	40Mbps
Remote Users	128	
Protocols	P2P, UPnP, NTP, DHCP, PPPoE	
Video/Audio Output		
HDMI/VGA Output	HDMI: 1920x1080p/60Hz, 1920x1080p/50Hz, 1600x1200/60Hz, 1280x1024/60Hz, 1280x720/60Hz, 1024x768/60Hz VGA: 1920x1080p/60Hz, 1920x1080p/50Hz, 1600x1200/60Hz, 1280x1024/60Hz, 1280x720/60Hz, 1024x768/60Hz	
Audio Output	1-ch, RCA	
Recording Resolution	6MP/5MP/4MP/3MP/1080p/960p/720p/D1/2CIF/CIF	
Synchronous Playback	4-ch	8-ch
Corridor Mode Screen	3/4	3/4/5/7/9
Decoding		

Decoding format	Ultra 265/H.265/H.264
Liveview/Playback	6MP/5MP/4MP/3MP/1080p/960p/720p/D1/2CIF/CIF
Capability	1 x 6MP@20, 1 x 5MP@30, 2 x 4MP@25, 2 x 3MP@30, 4 x 1080p@25, 8 x 960p@25, 8 x 720p@30
Hard Disk	
SATA	1 SATA interface
Capacity	up to 6TB for each disk
External Interface	
Network Interface	1 RJ45 10M/100M self-adaptive Ethernet Interface
USB Interface	Rear panel: 2 x USB2.0
Supported Standard	IEEE 802.3at, IEEE 802.3af
General	
Power Supply	12V DC Power Consumption: ≤9 W (without HDD)
Working Environment	-10°C ~ +55°C (+14°F ~ +131°F), Humidity ≤ 90% RH (non-condensing)
Dimensions (W×D×H)	260mm × 240mm × 46mm (10.2"×9.4"×1.8")
Weight (without HDD)	1kg (2.20 lb)

Dimensions

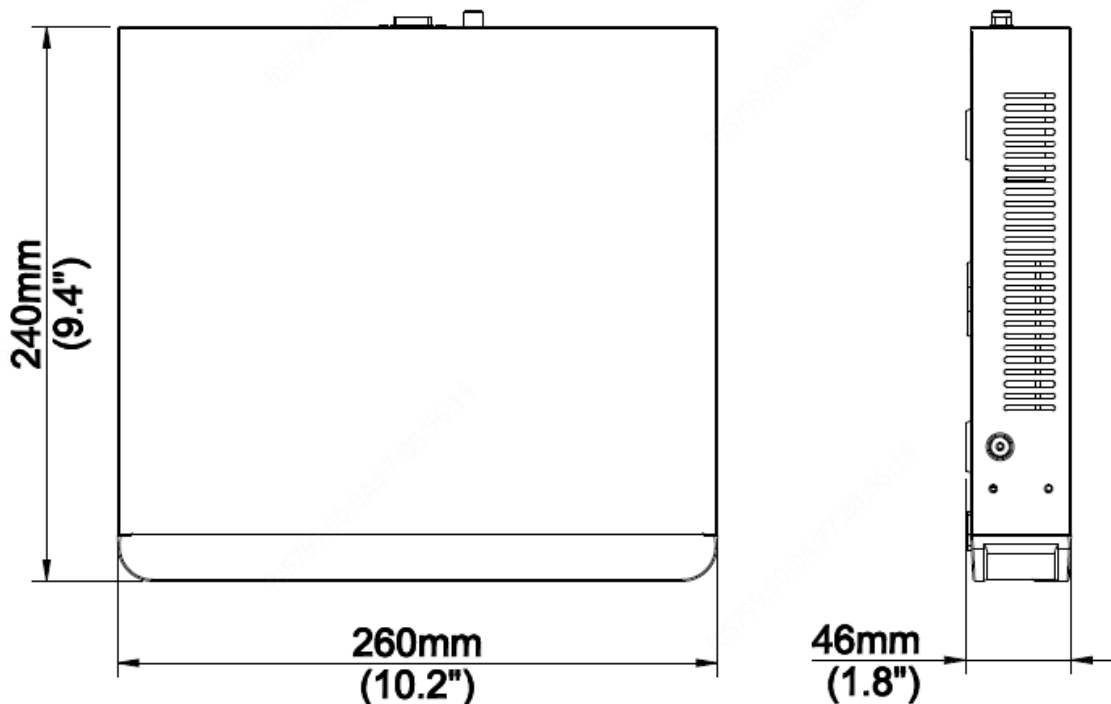

Rear Panel

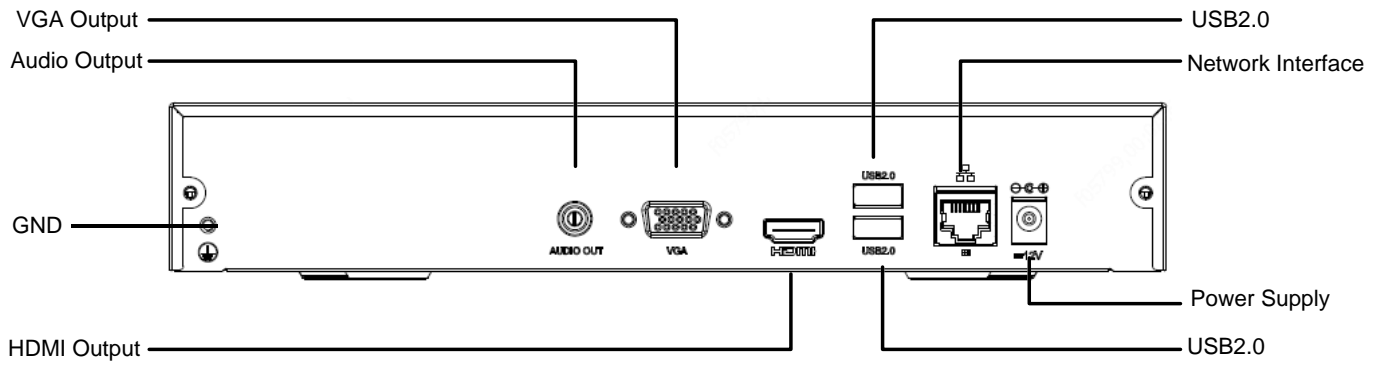

Zhejiang Uniview Technologies Co., Ltd.

Building No.10, Wanlun Science Park, Jiangling Road 88, Binjiang District, Hangzhou, Zhejiang, China

Email: overseasbusiness@uniview.com; globalsupport@uniview.com

<http://www.uniview.com>

©2019 Zhejiang Uniview Technologies Co., Ltd. All rights reserved.

* Product specifications and availability are subject to change without notice.